

Fig. 1.

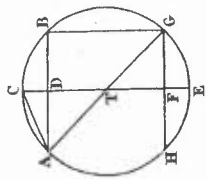

Fig. 2.

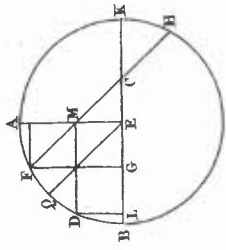

Fig. 3.

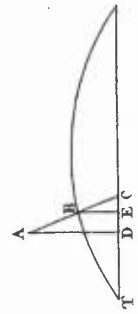

Fig. 4.

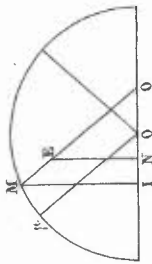

Fig. 5.

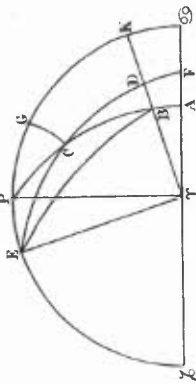

Fig. 6.

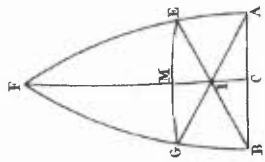

Fig. 7.

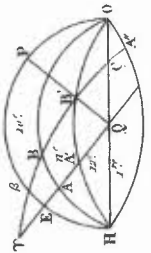

Fig. 8.

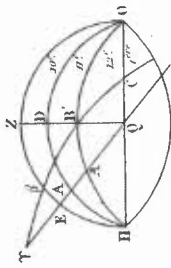

Fig. 9.

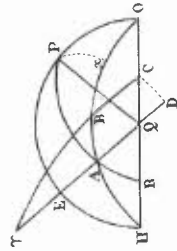

Fig. 10.

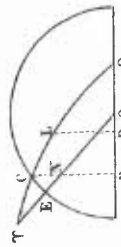

Fig. 11.

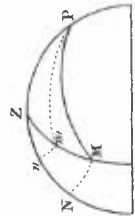

Fig. 14.

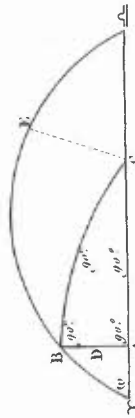

Fig. 13.

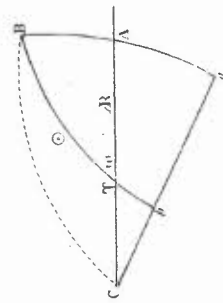

Fig. 16.

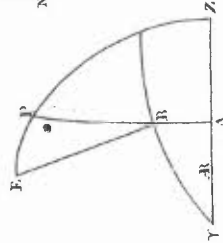

Fig. 12.

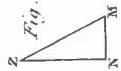

Fig. 17.

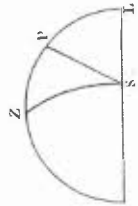

Fig. 18.

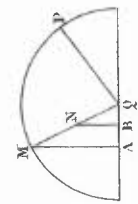

Fig. 19.

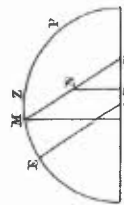

Fig. 24.

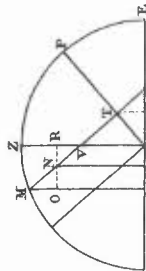

Fig. 20.

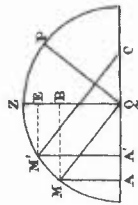

Fig. 25.

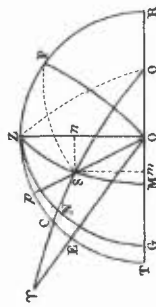

Fig. 21.

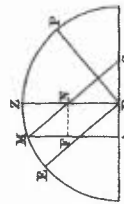

Fig. 26.

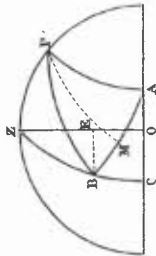

Fig. 22.

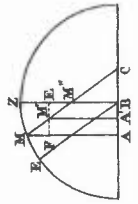

Fig. 27.

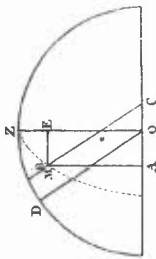

Fig. 23.

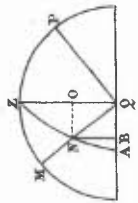

Fig. 28.

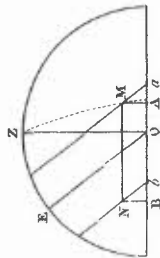

Fig. 29.

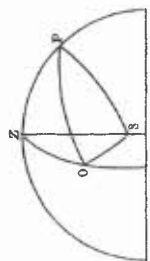

Fig. 30.

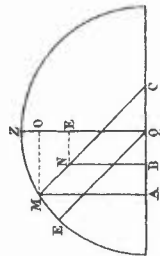

Fig. 31.

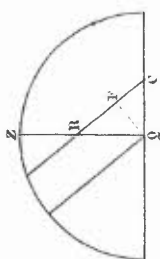

Fig. 33.

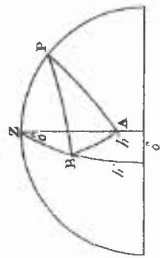

Fig. 34.

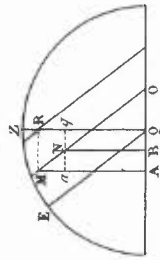

Fig. 36.

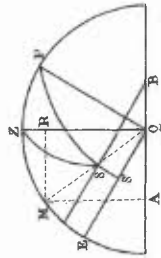

Fig. 37.

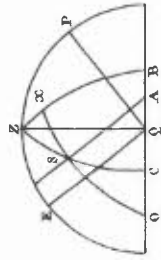

Fig. 50.

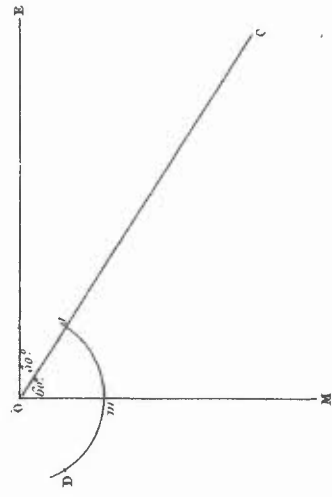

Fig. 42.

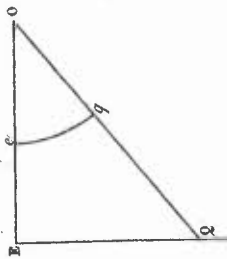

Fig. 40.

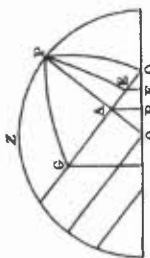

Fig. 39.

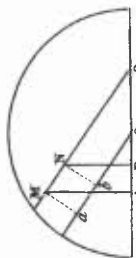

Fig. 38.

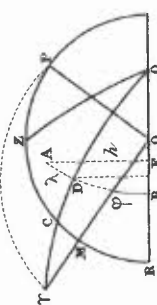

Fig. 44.

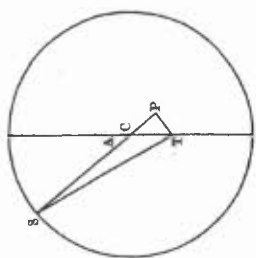

Fig. 43.

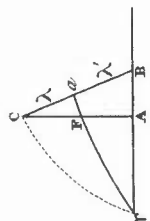

Fig. 42.

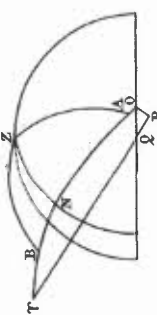

Fig. 46.

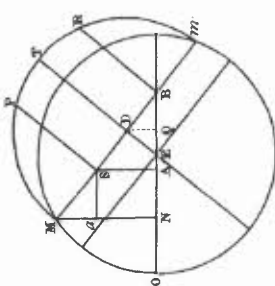

Fig. 47.

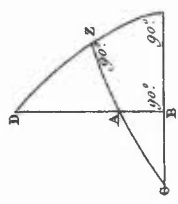

Fig. 48.

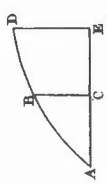

Fig. 60.

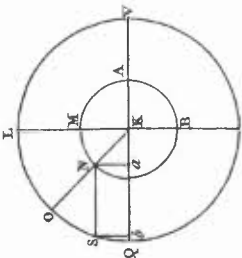

Fig. 51.

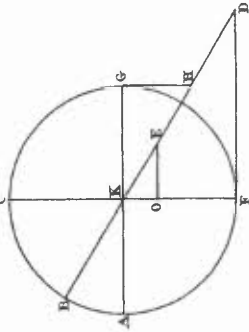

Fig. 49.

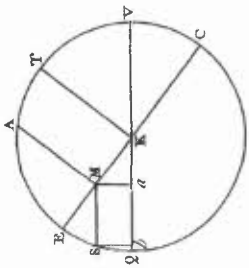

Fig. 52.

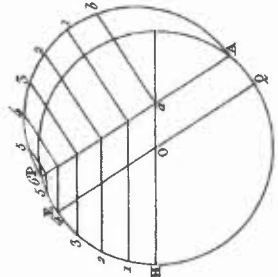

Fig. 45.

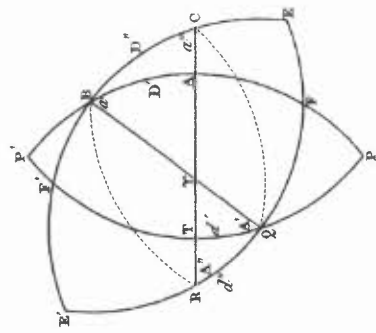



Fig. 62.

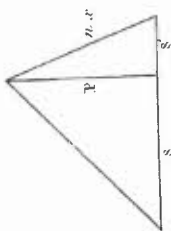

Fig. 63.

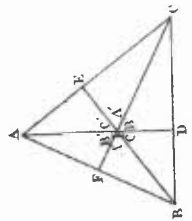

Fig. 64.

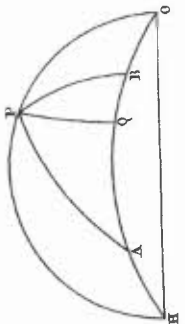

Fig. 65.

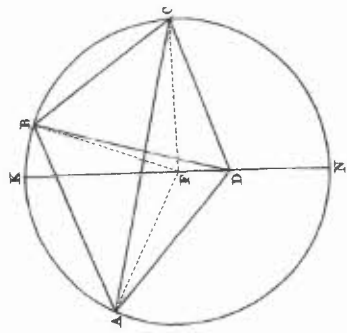

Fig. 66.

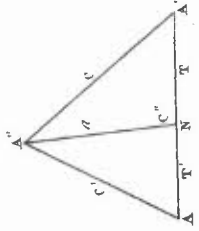

Fig. 67.

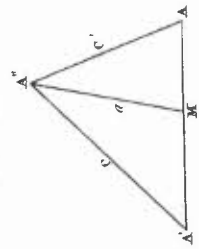

Fig. 68.

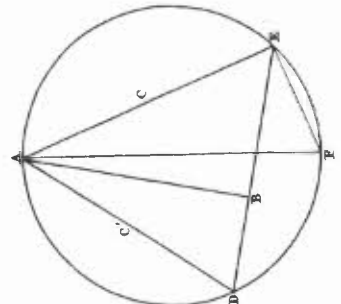

Fig. 69.

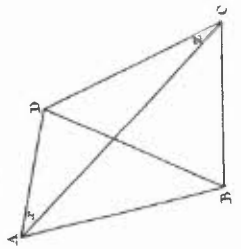

Fig. 70.

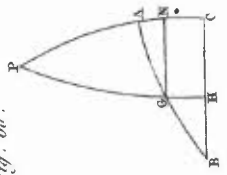

Fig. 71.

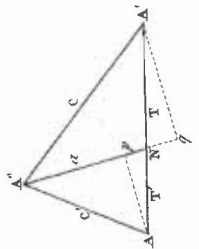

Fig. 72.

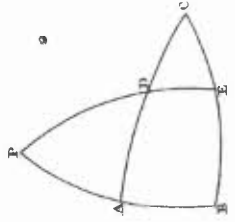

Fig. 73.

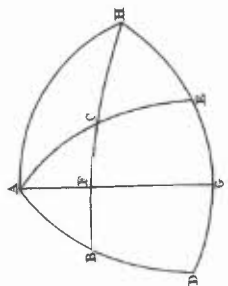

Fig. 74.

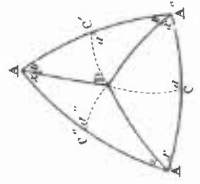

Fig. 73.  
Carré Horaire général.

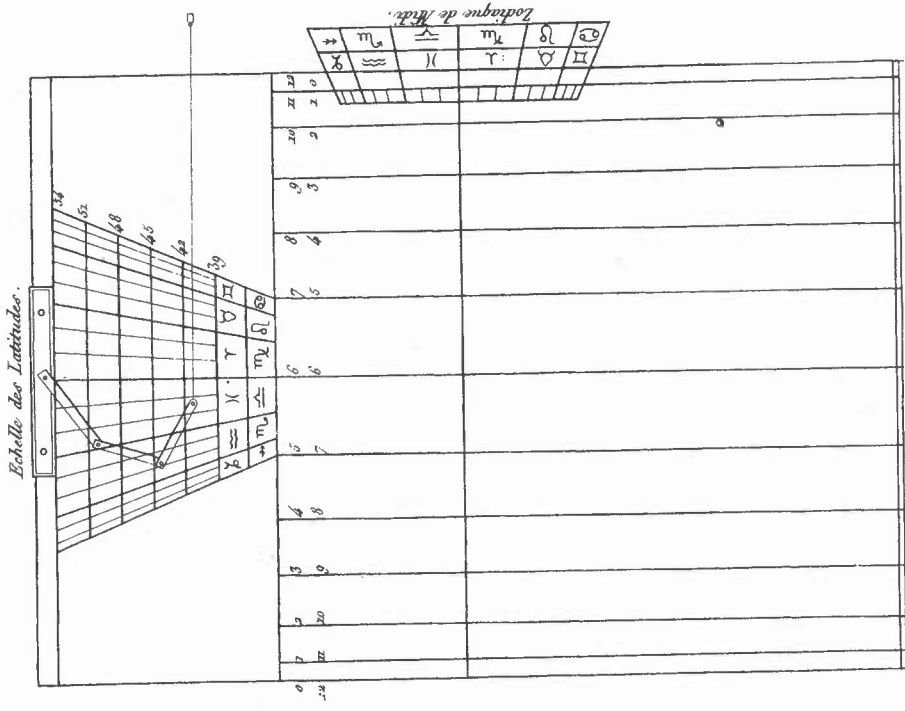

Fig. 74.  
Analemme Rectiligne universel.

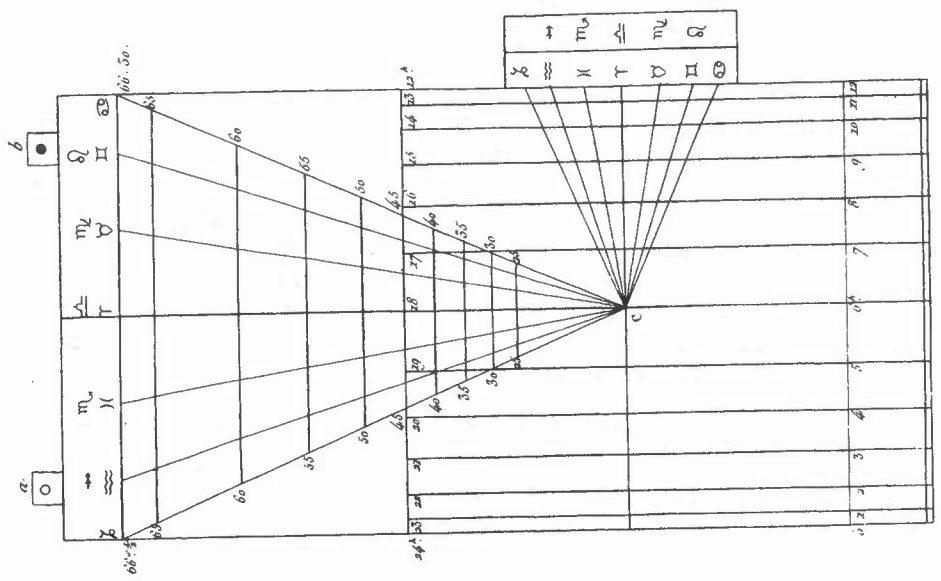

Fig. 76.  
Analemme de St. Rigaud.

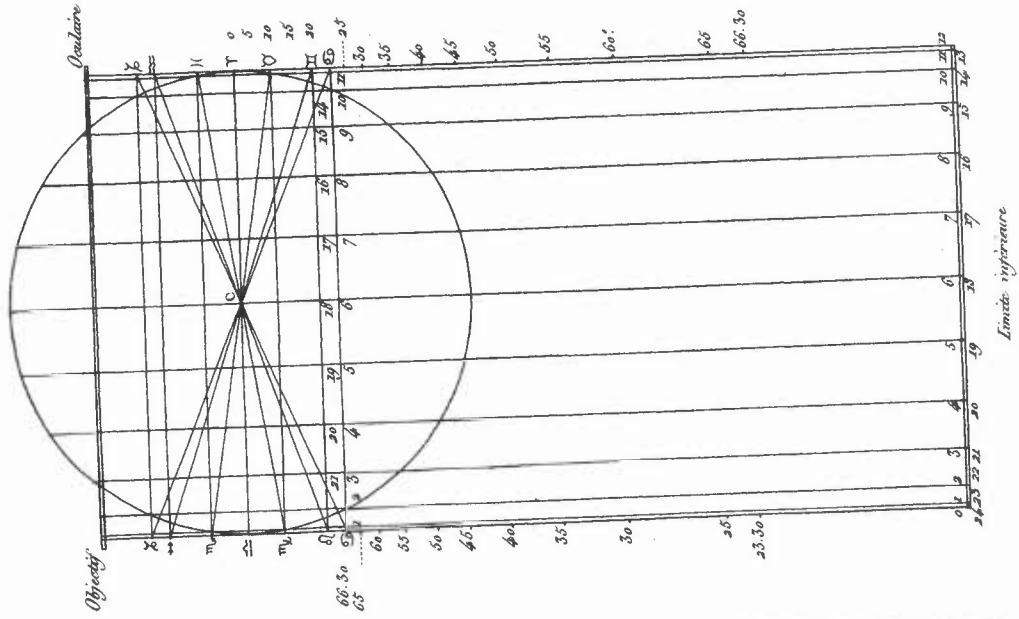

Fig. 76.

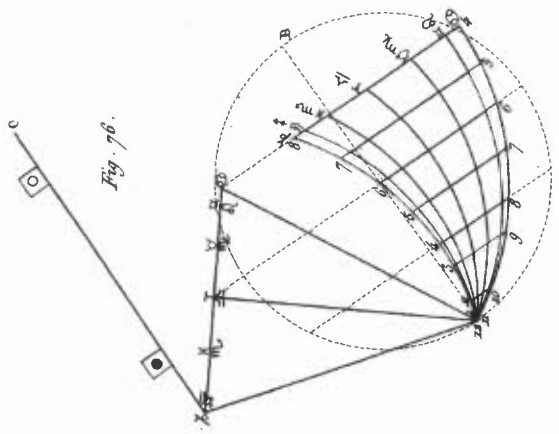

Fig. 77.

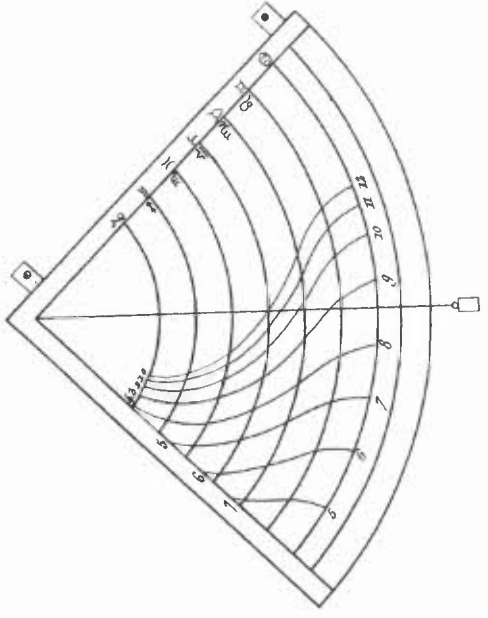

Fig. 78.

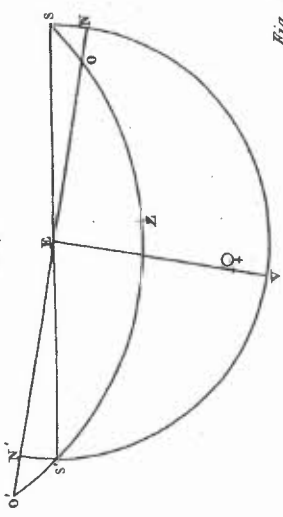

Fig. 79.

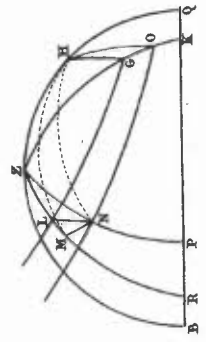

Fig. 80.

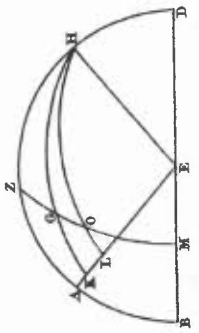

Fig. 81.

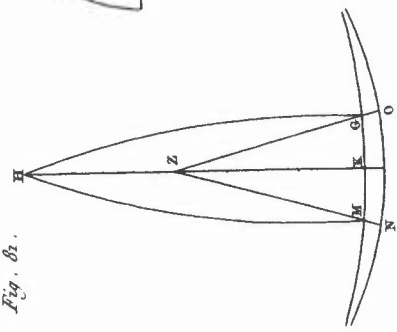

Fig. 82.

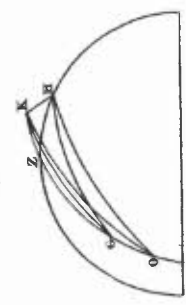

Fig. 83.

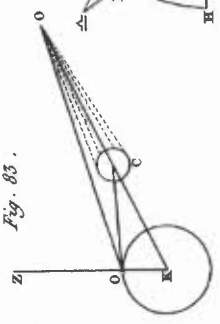

Fig. 84.

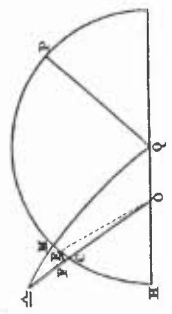

Fig. 85.

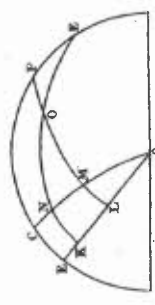

Fig. 86.

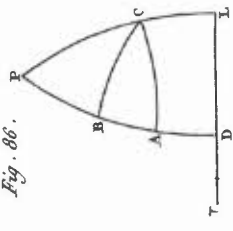

Fig. 87.

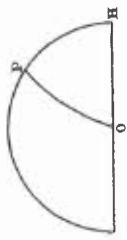

Fig. 88.

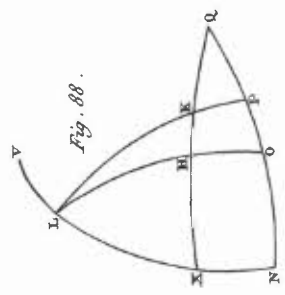

Fig. 89.

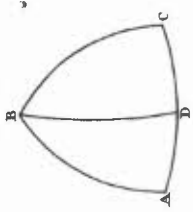

Fig. 90.

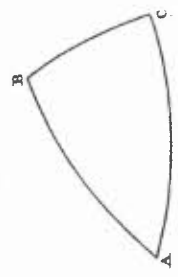

Fig. 91.

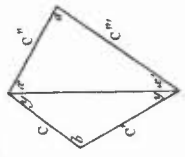



Fig. 92.

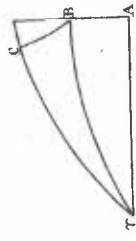

Fig. 93.

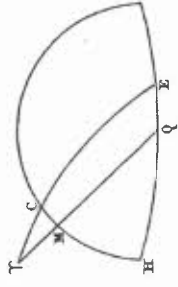

Fig. 94.

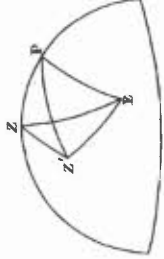

Fig. 95.

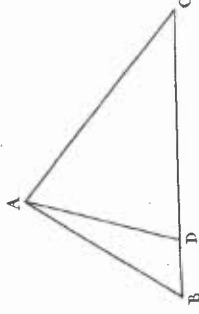

Fig. 96.

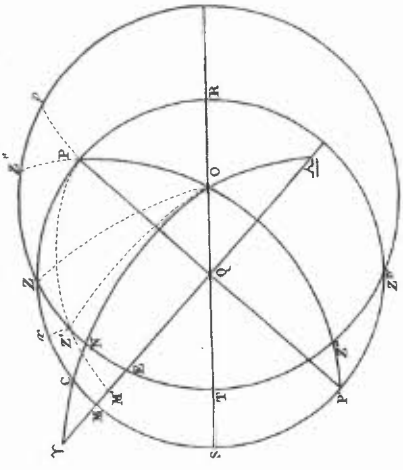

Fig. 97.

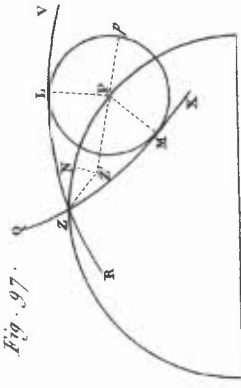

Fig. 98.

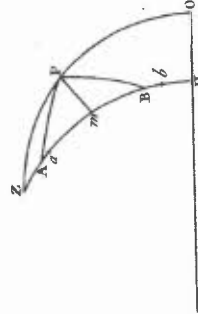

Fig. 99.

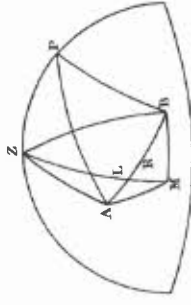

Fig. 100.

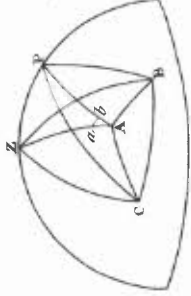

Fig. 101.

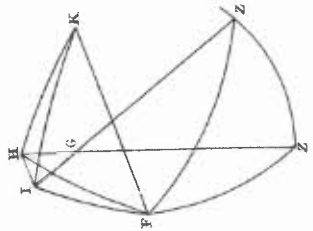

Fig. 102.

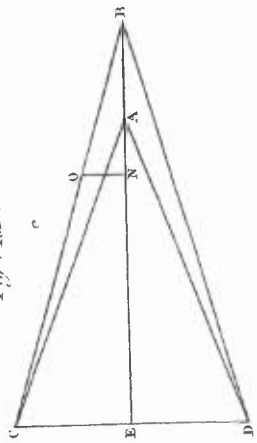

Fig. 103.

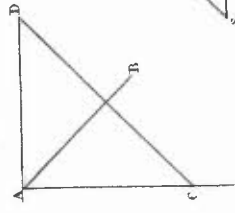

Fig. 104.

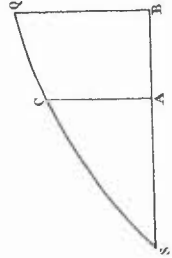





Fig. 129.

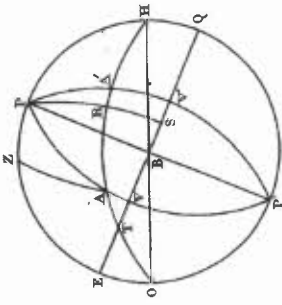

Fig. 130.

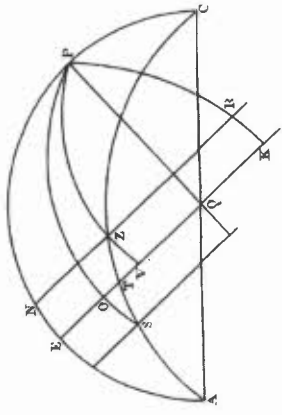

Fig. 131.

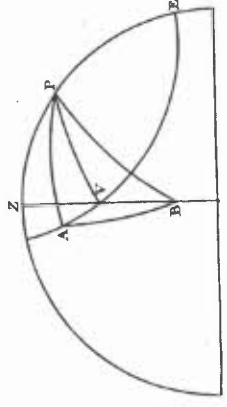

Fig. 132.

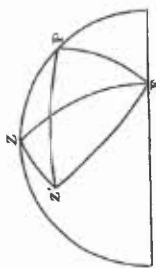

Fig. 134.

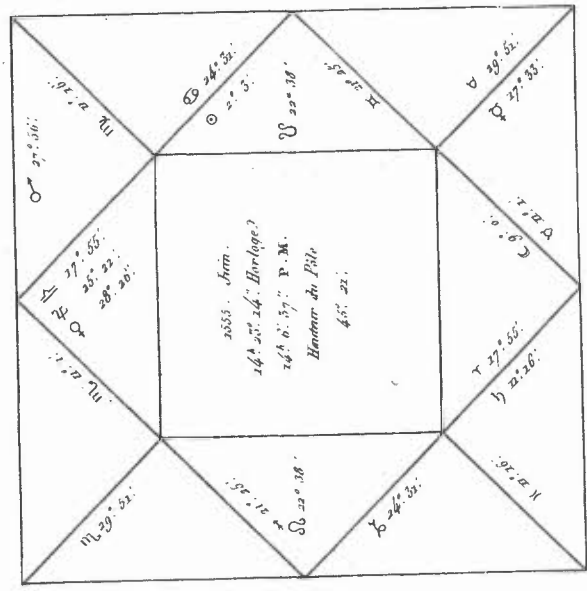

Fig. 136.

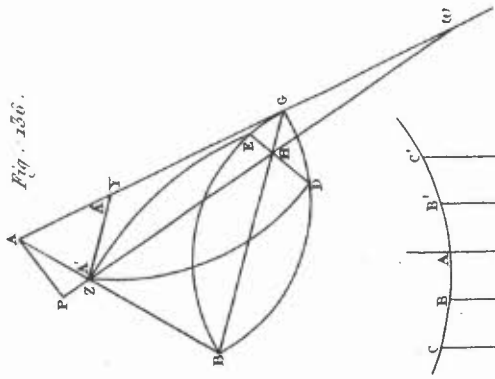

Fig. 137.

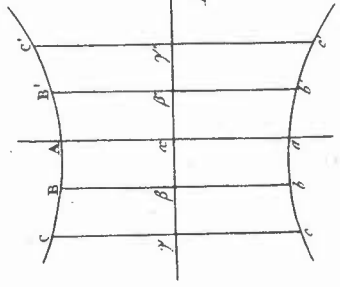

Fig. 133.

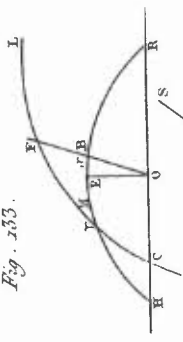

Fig. 135.

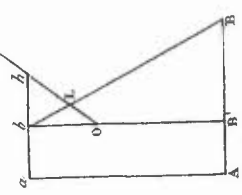



Fig. 142.

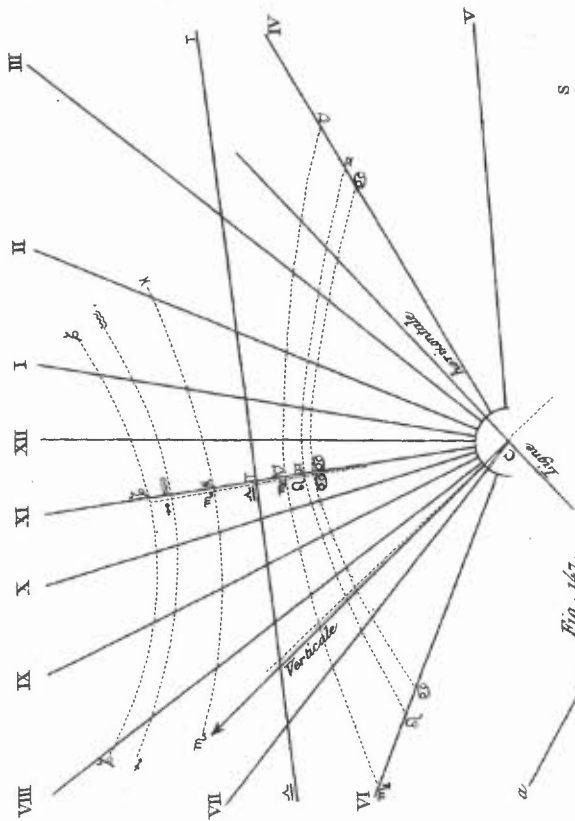

Fig. 145.

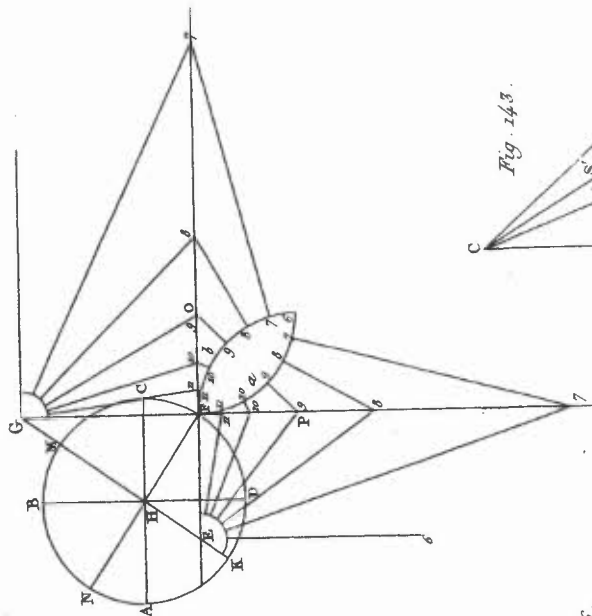

Fig. 147.

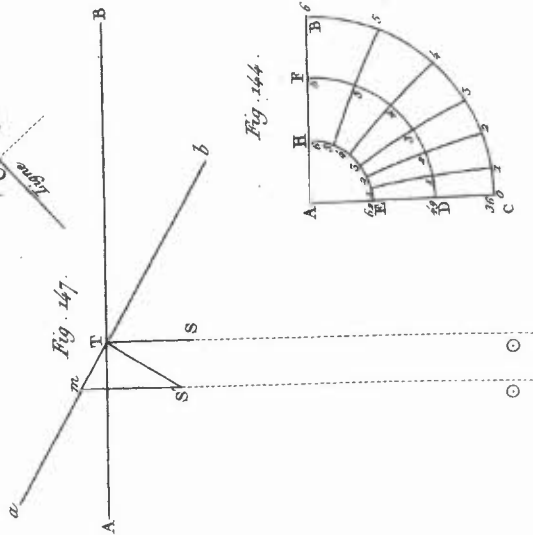

Fig. 146.

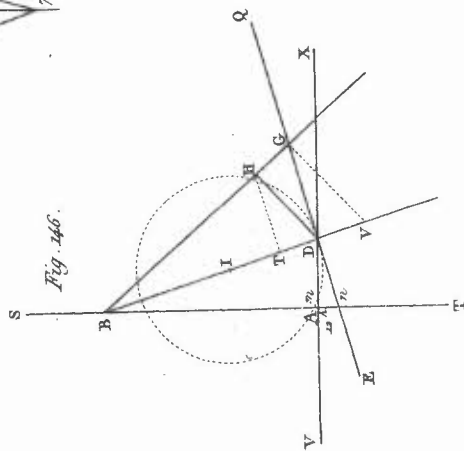

Fig. 144.

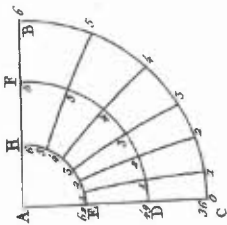

Fig. 143.

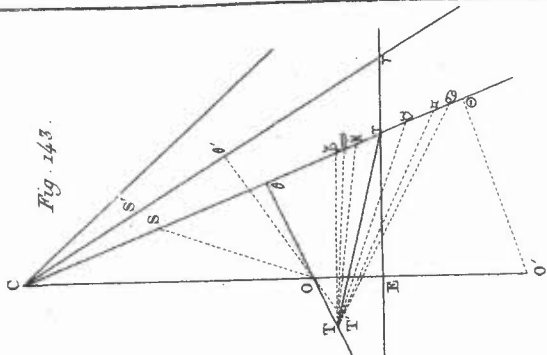

Fig. 152.

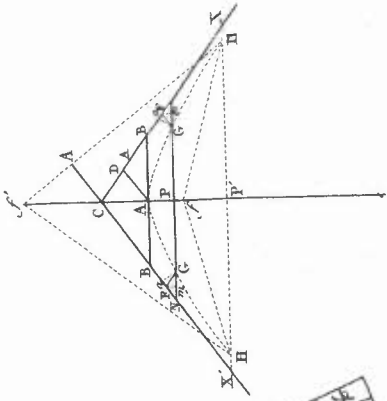

Fig. 151.

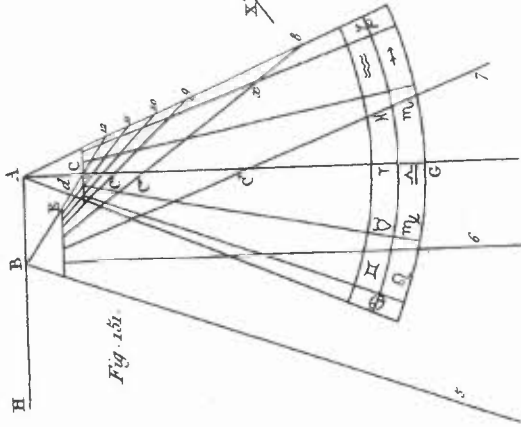

Fig. 148.

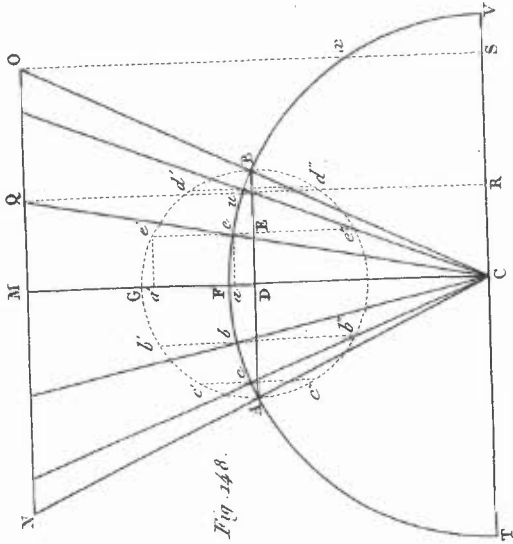

Fig. 153.

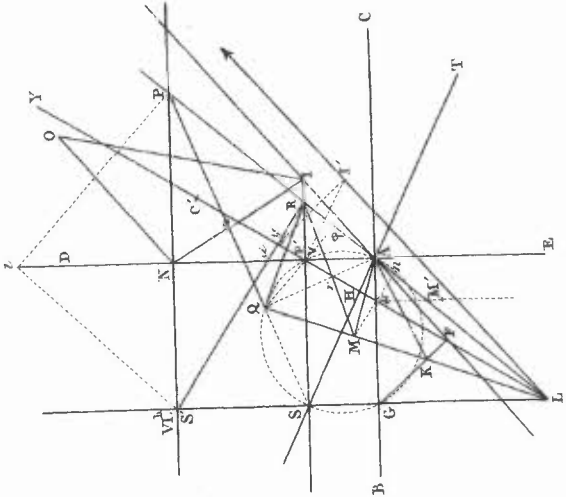

Fig. 149.

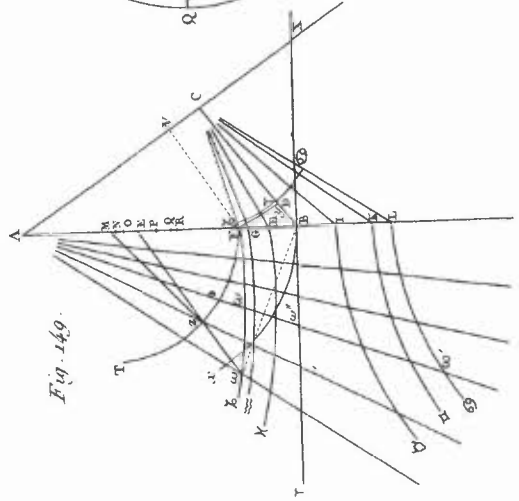

Fig. 150.

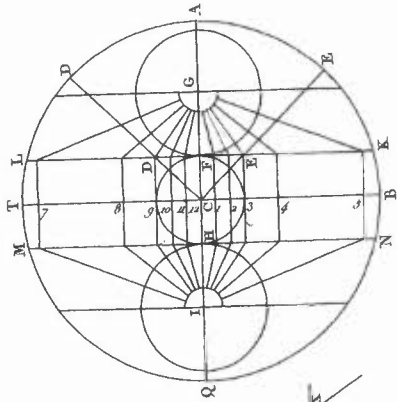

Fig. 154

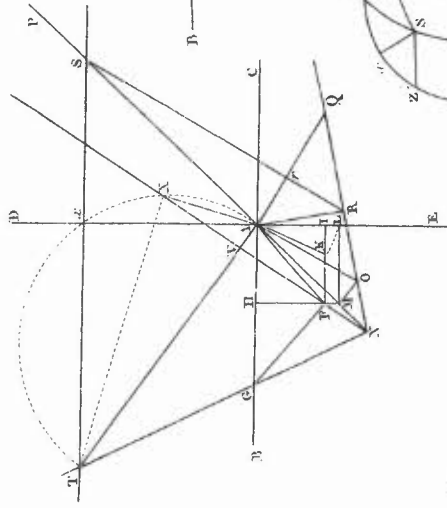

Fig. 157

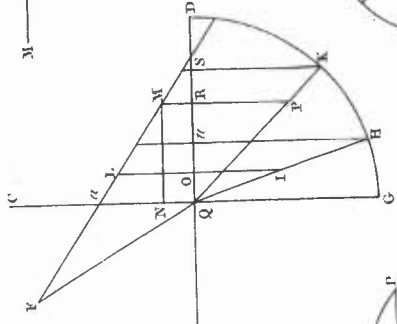

Fig. 159

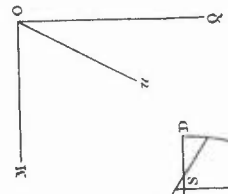

Fig. 158

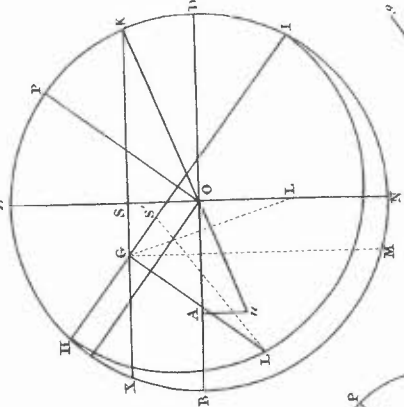

Fig. 156

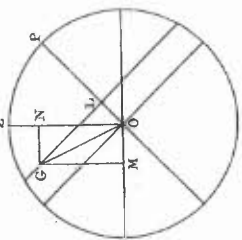

Fig. 155

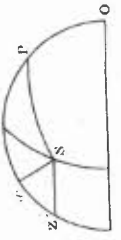

Fig. 160

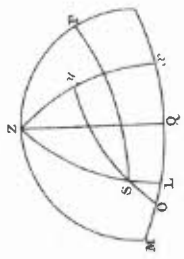

Fig. 165

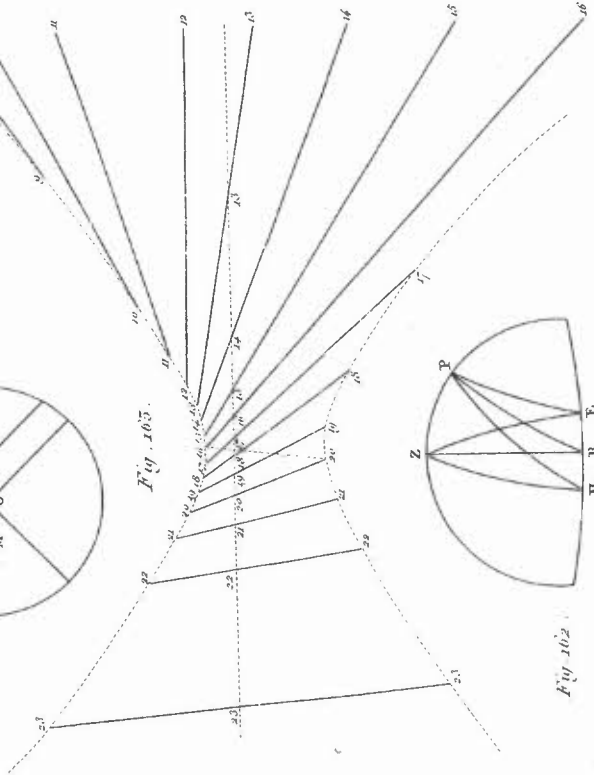

Fig. 161

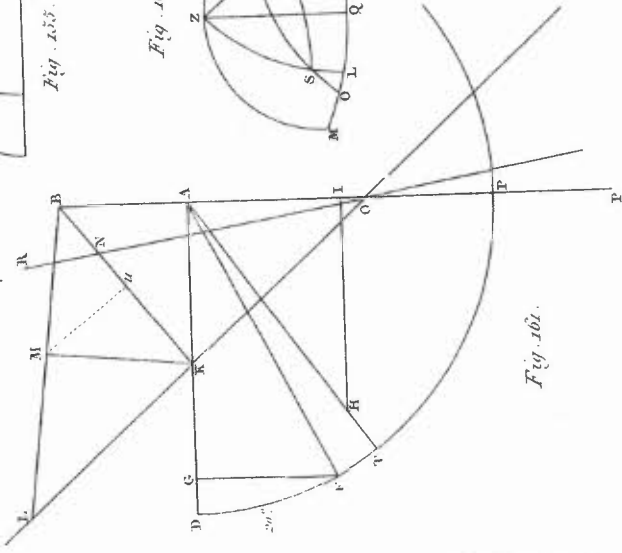

Fig. 162

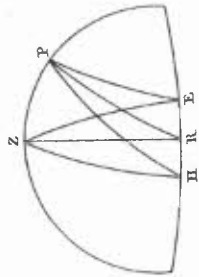



Fig. 164.

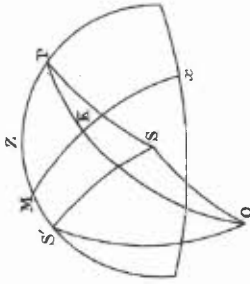

Fig. 165

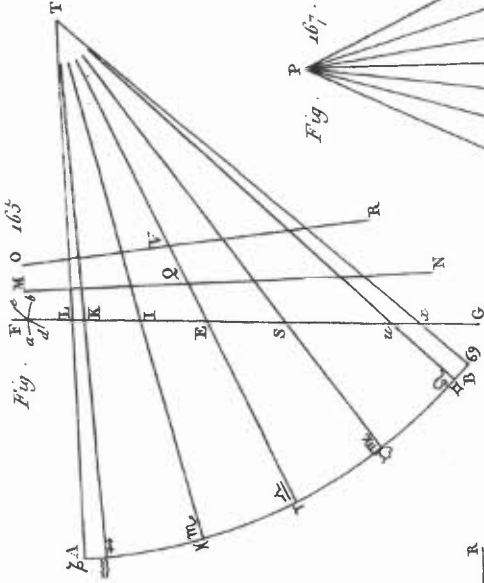

Fig. 166.

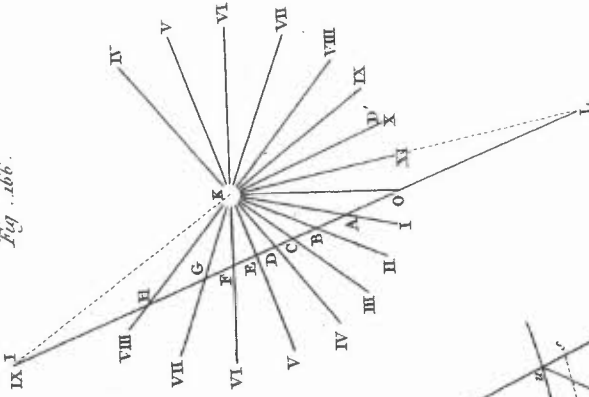

Fig. 167.

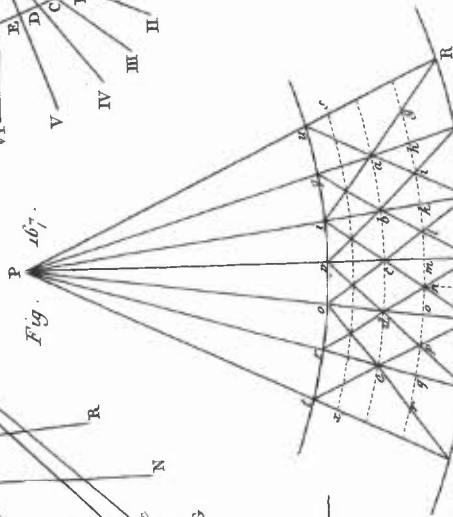

Fig. 170.

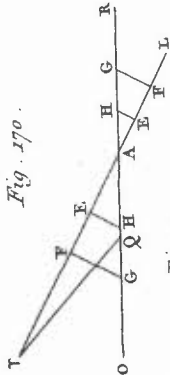

Fig. 172.

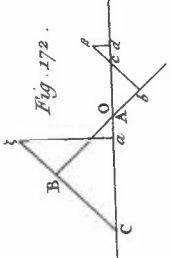

Fig. 171.

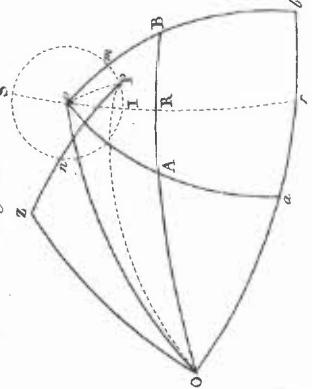

Fig. 169.

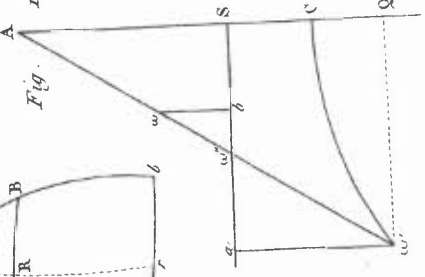

Fig. 168.

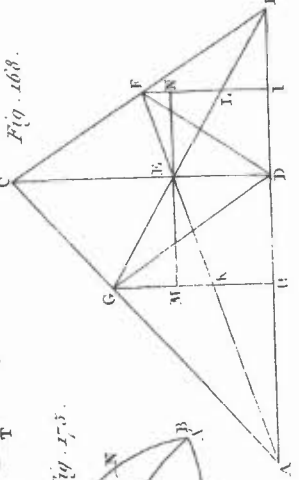

Fig. 173.

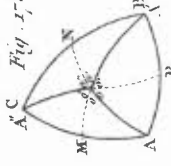

Fig. 173.

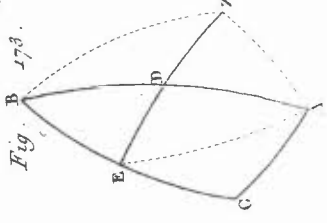

Fig. 174.

